

Exploded View - MKTH1223C-16

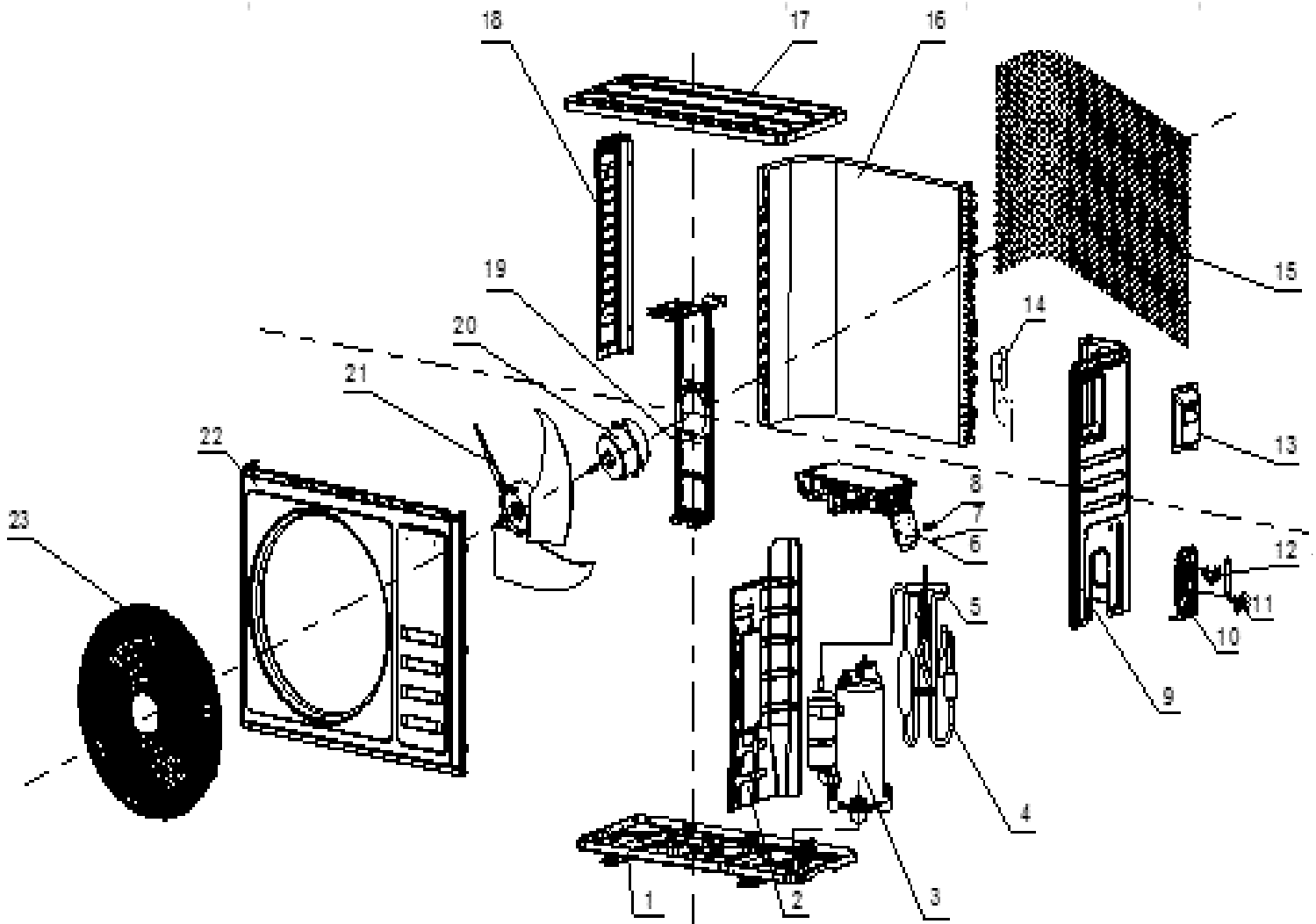

Exploded View - MKTH1223C-16

No.	Part No.	Part Name	Qty	Remark
1	41202-000216	Base	1	
2	41208-001156	Partition plate	1	
3	92014-000760	Compressor and accessories	1	
4	92007-010234	4-way valve assembly	1	
5	92008-000289	4-way valve	1	
6	31201-003024	Outdoor PCB Assembly	1	
7	42001-000036	Cable clamp	1	
8	11304-100117	Terminal	1	
9	41205-000639	Right plate	1	
10	41204-000018	Valve supporter	1	
11	92007-001041	Three-way valve	1	
12	92007-007317	Two-way valve	1	
13	41201-000106	Eelectronic Box Cover	1	
14	92007-009537	Capillary assembly	1	
15	42011-000184	Grille	1	
16	92011-008102	Condenser	1	
17	41207-000683	Top cover	1	
18	41205-000133	Left plate	1	
19	41203-000953	Outdoor motor supporter	1	
20	22001-000555	Outdoor motor	1	
21	42004-000107	Propeller fan	1	
22	41206-000216	Front plate	1	
23	42011-000038	Fan guard	1	
24	10104-100055	Outdoor Temp. sensor assembly	1	Not shown in explosion view
25	A2005-000530	Base carton	1	
26	A1201-026036	Cabinet carton	1	
27	A1202-000039	Base foaming	1	
28	41213-000030	Cover foaming	1	