

Exploded View - MKTH1823E-16

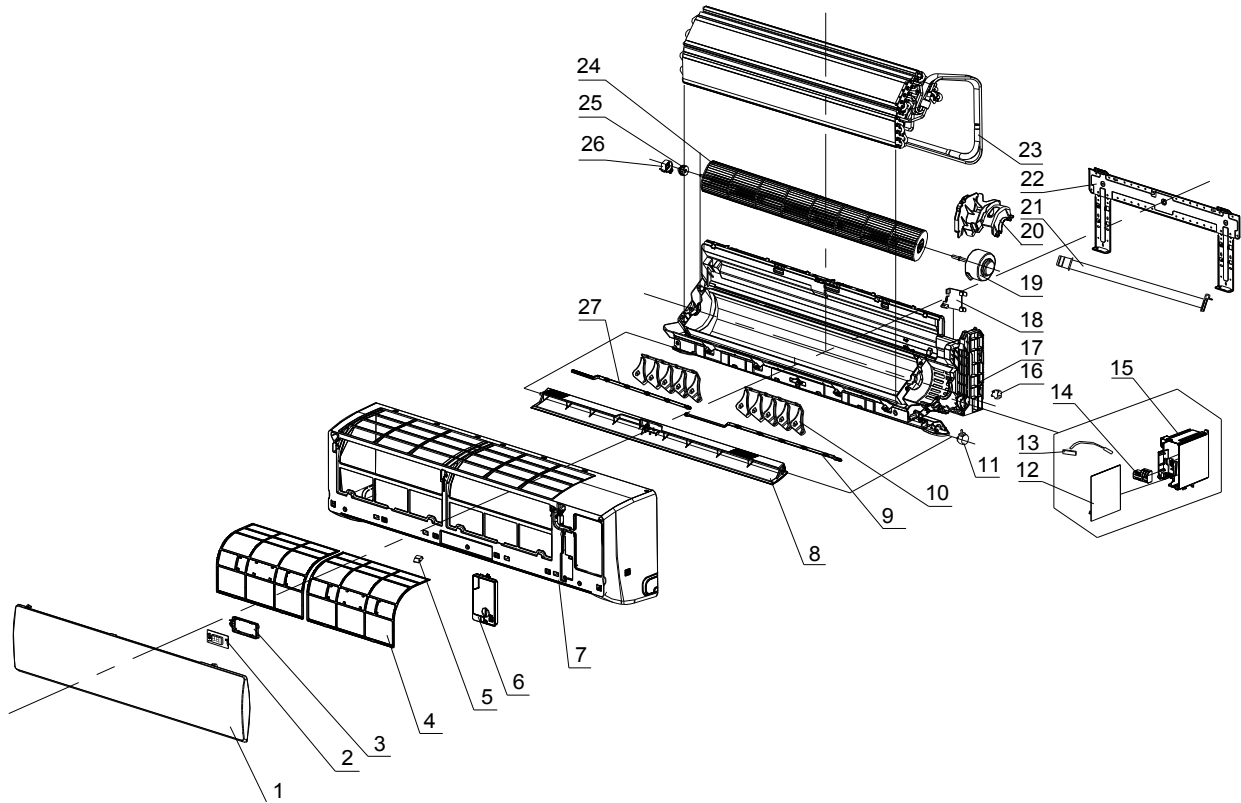

No.	Part No.	Part Name	Q'ty	Price(USD)	Remark
1	41106-002201	Front Panel	1	4.07	
2	31102-000084	Display PCB	1	3.79	
3	42003-000001	Display PCB Box	1	0.11	
4	42008-000076	Air Filter	2	0.95	
5	41108-000066	Screw Cover	3	0.05	
6	41211-000079	Electrical Box Cover	1	0.72	
7	41106-002356	Face Frame	1	6.65	
8	41103-000149	Vane	1	1.74	
9	41101-000166	Vertical Vane Connector	1	0.25	
10	41101-000067	Vertical Vane Assembly	2	0.17	
11	22001-000321	Vane Motor	1	1.63	
12	31101-002303	Main PCB	1	15.74	
13	10104-100014	Indoor Sensor Assembly	1	0.60	
14	11304-100063	Terminal	1	0.88	
15	41105-000427	Electrical Box	1	4.08	
16	22001-000318	Step Motor	1	1.47	
17	41102-000047	Base	1	9.95	
18	41101-000242	In And Out Pipe Fixer	1	0.18	
19	22001-000409	Indoor Motor	1	14.35	
20	41108-000013	Indoor Motor Cover	1	0.48	
21	42009-000011	Drainage Hose	1	0.62	
22	41109-000041	Installation Plate	1	0.99	
23	92011-010928	Evaporator	1	37.19	
24	42004-000012	Cross Fan	1	4.59	
25	42007-000009	Bearing Mount	1	0.26	
26	41101-000251	Bearing Mount holder	1	0.07	
27	22013-004955	Remote Controller	1	3.64	
28	42001-000012	Remote Controller supporter	1	0.14	Not shown in Explosion view
29	A1101-024080	Indoor Carton	1	3.45	
30	A2006-000046	Left Foaming	1	0.62	
31	A2006-000027	Right Foaming	1	0.62	