

Exploded View - CAC1813HA15

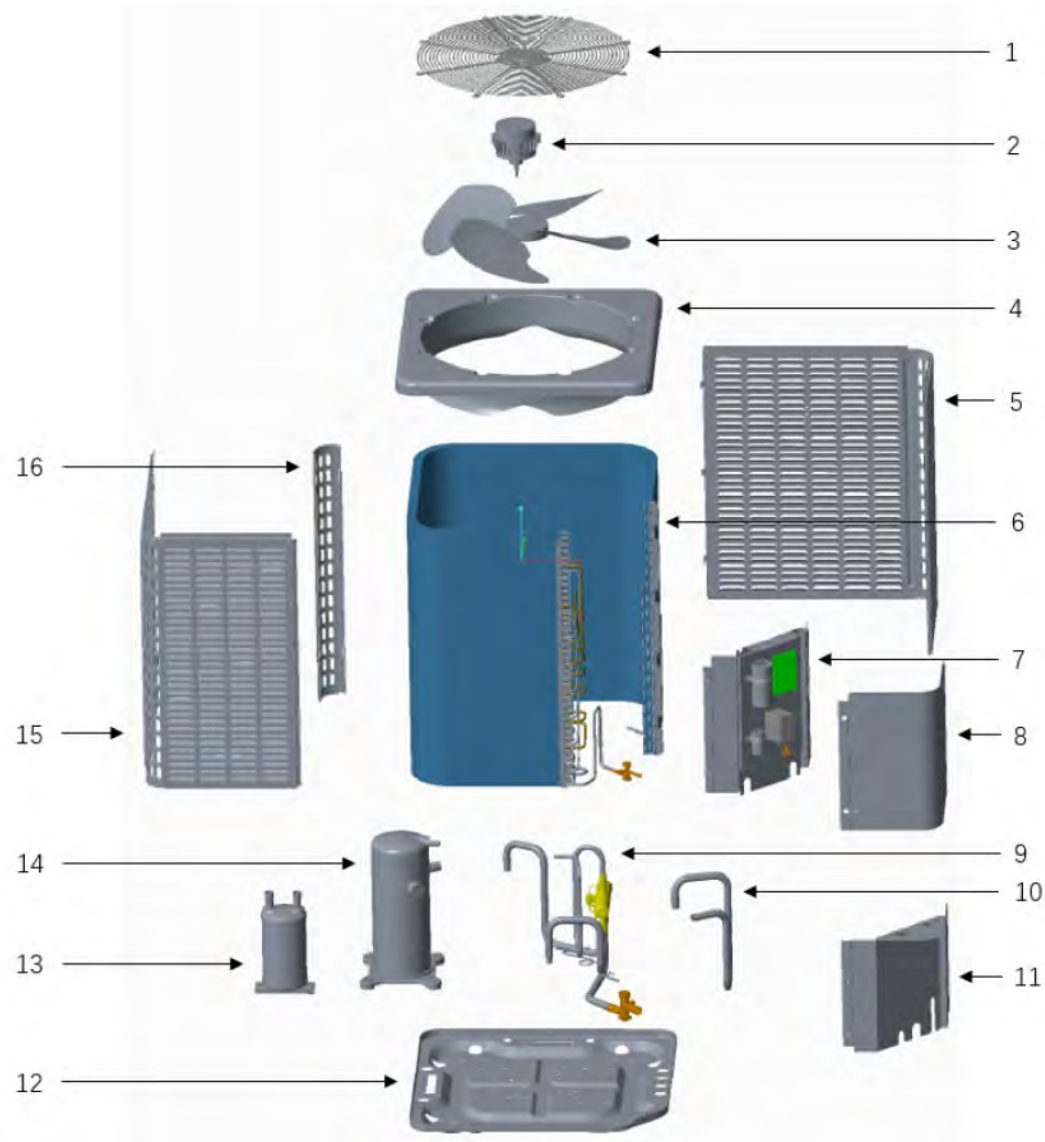

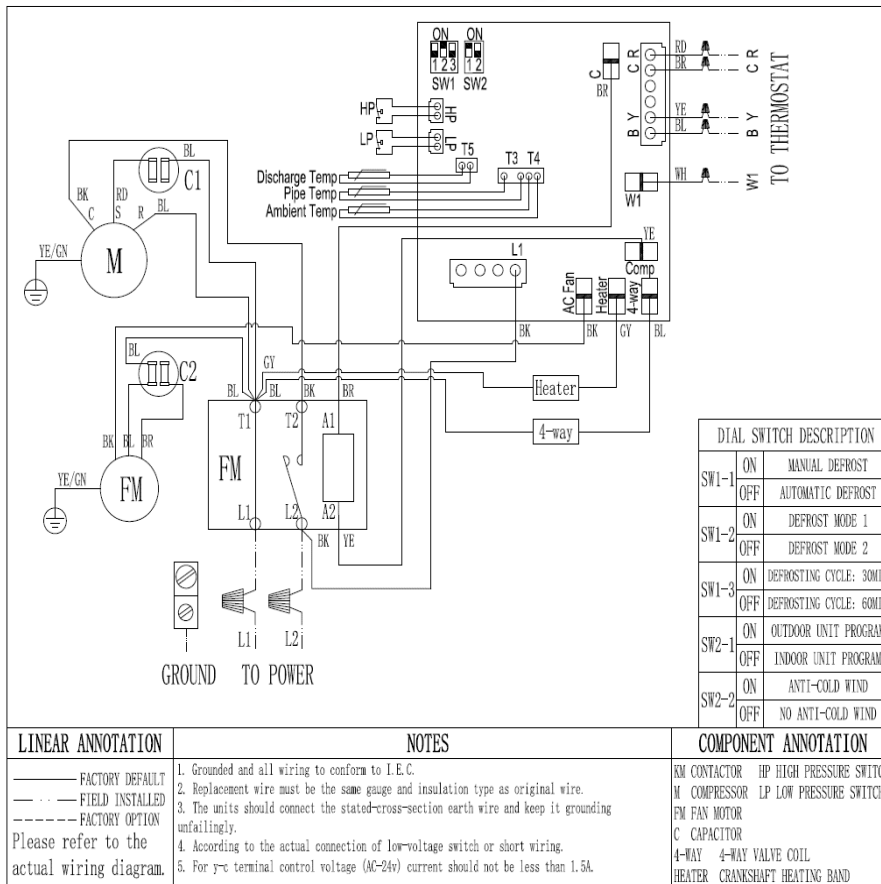

No.	Part Name	Quantity	Price(\$)	BOM Code	Remark
1	Top air outlet grille	1		91037801	13.92
2	Fan motor	1		91043430	41.69
3	Axial-flow fan	1		91038106	15.20
4	Top cover	1		91043103	18.61
5	Right side panel	1		91043110	15.73
6	Condenser assembly	1		91044599	233.56
6.1	Condenser component	1		91044295	214.30
6.2	Shunt components	1		91043158	9.56
6.3	Gas collector assembly	1		91043162	8.00
6.4	High pressure valve assembly	1		91044764	3.17
7	Electronic control part	1		91044613	54.92
7.1	Electronic control mounting plate	1		91043105	7.30
7.2	PCB mounting base	1		91043106	2.18
7.3	PCB	1		91034034	21.54
7.4	AC contactor	1		91041306	14.51
7.5	Compressor capacitor	1		91031797	3.31
7.6	Fan capacitor	1		91042834	1.80
7.7	Brass binding post	1		91043061	1.16
7.8	Ambient temperature sensor	1		91041298	0.48
8	Upper side panel	1		91043104	6.82
9	4-way valve assembly	1		91044770	24.97
10	Gas return pipe assembly	1		91044768	9.00
11	Lower side panel	1		91043108	4.02
12	Base pan components	1		91043100	21.61
13	Compressor	1		91042774	412.12
14	Gas-liquid separator	1		91044851	17.81
15	Left side panel	1		91043109	15.26
16	Support plate	1		91043111	2.93
17	Crankshaft heating belt	1		91040126	4.76
18	Condenser temperature sensor	1		91041297	0.74
19	Discharge temperature sensor	1		91041299	0.94
20	4-way valve coil	1		91045862	3.17