

Exploded View - AHC36HA15

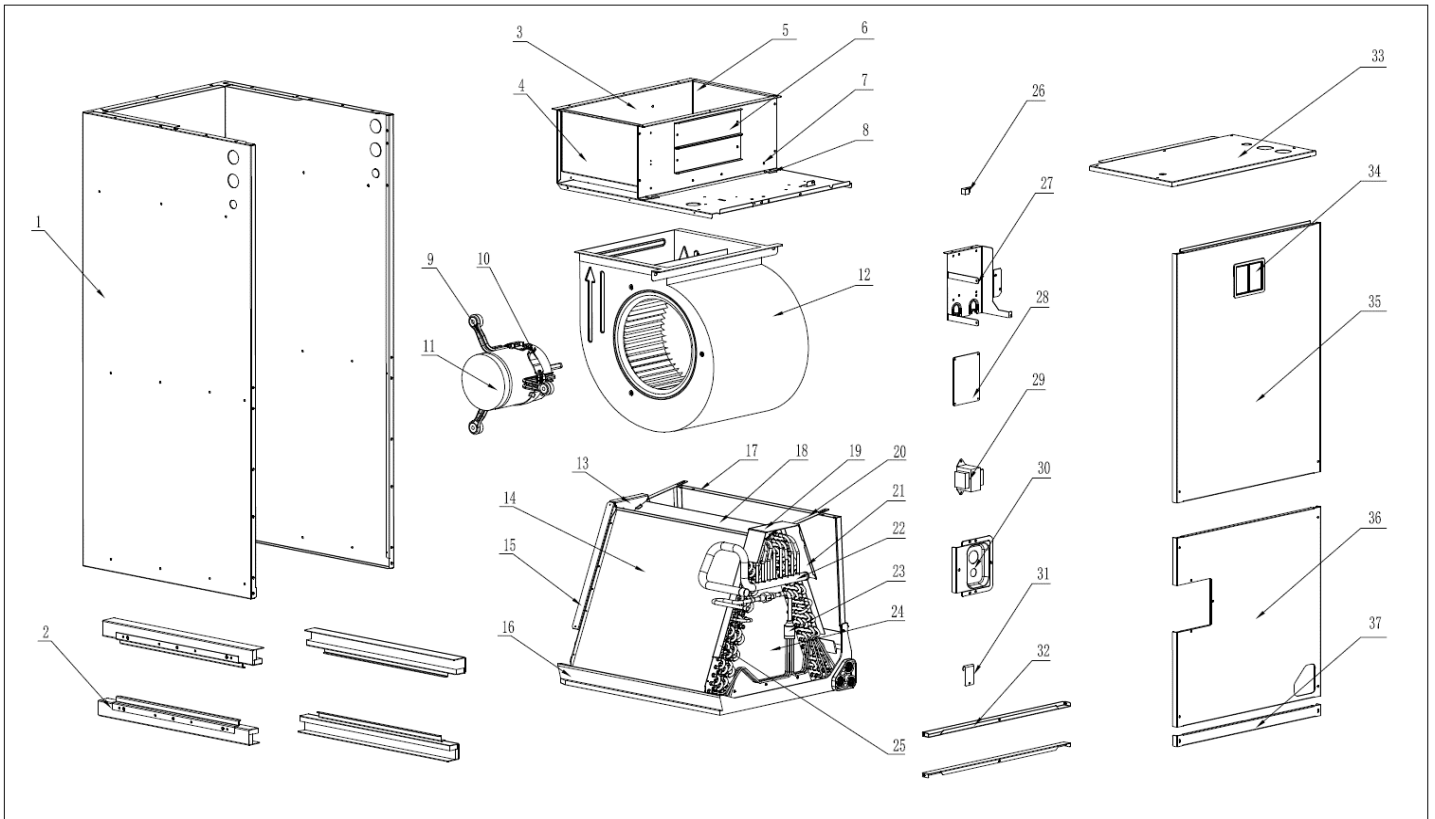

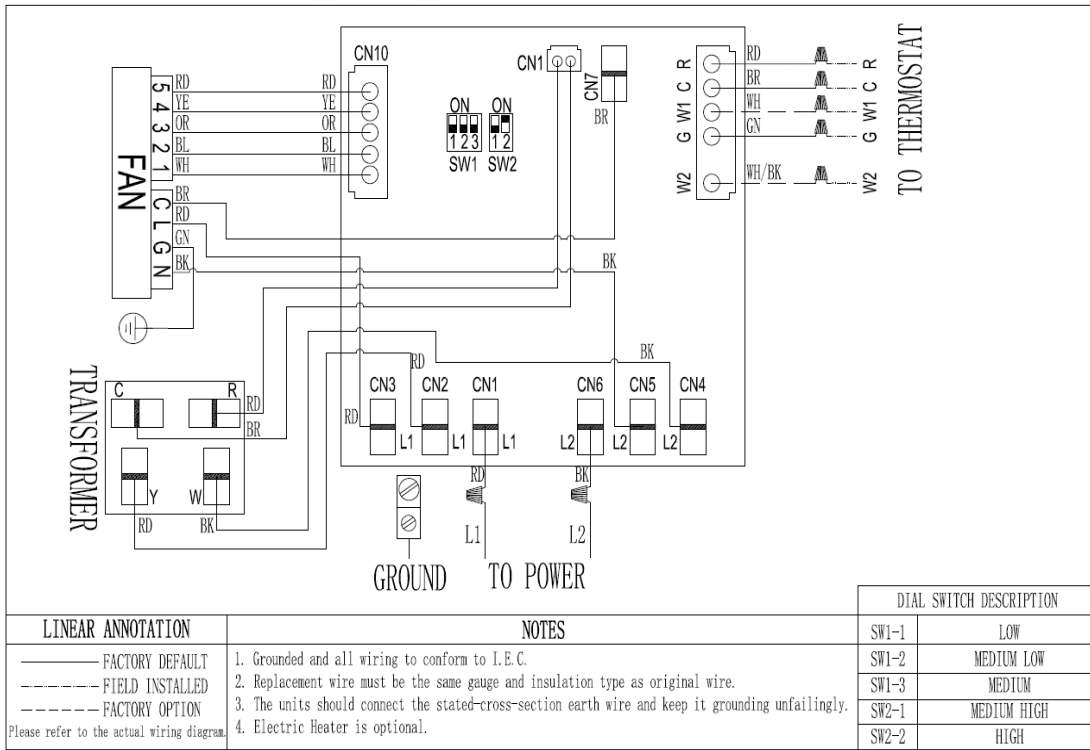

No.	Part Name	Quantity	Price(\$)	BOM Code	Remark
1	Base pan cotton sticking assembly	1		91043684	60.68
2	Drain pan support plate cotton sticking assembly	4		91043685	4.09
3	Wind wheel fixing plate	1		91043686	12.37
4	Left side panel of air duct	1		91043688	2.27
5	Right side panel of air duct	1		91043689	2.27
6	Electric heater sealing plate	2		91043691	1.73
7	Front side panel of air duct	1		91043687	4.66
8	Wind wheel mounting block	2		91043690	8.63
9	Motor fixing beam assembly	3		91043693	1.32
10	Motor clamp	1		91043692	0.80
11	Fan motor	1		91044855	241.26
12	Wind wheel volute	1		91038107	53.66
13	Evaporator fixing plate 1	1		91043696	0.88
14	Evaporator	2		91044431	96.71
15	Evaporator water baffle 1	2		91043697	0.56
16	Plastic drain pan cotton sticking assembly	1		91043694	18.98
17	Sheet metal drain pan cotton sticking assembly	1		91043695	6.11
18	Evaporator sealing plate cotton sticking assembly	1		91043701	0.95
19	Evaporator fixing plate 2	1		91043698	1.03
20	Connecting plate	2		91043703	3.38
21	Evaporator water baffle 3	1		91043700	0.79
22	Evaporator gas collector pipe assembly	1		91043682	13.56
23	Evaporator shunt pipe assembly	1		91043683	23.44
24	Evaporator connecting plate	2		91043702	5.22
25	Evaporator water baffle 2	1		91043699	0.74
26	Brass binding post	1		91043061	1.16
27	Electric control mounting plate	1		91043708	1.62
28	PCB	1		91034032	5.29
29	Transformer	1		91041237	14.66
30	Piping cover cotton sticking assembly	1		91043705	1.32
31	Drain pan fixing block	1		91043711	0.22
32	Support bar	2		91043709	0.70
33	Electric control box cover cotton sticking assembly	1		91043707	4.94
34	Circuit breaker sealing plate	1		91044424	0.41
35	Upper side panel cotton sticking assembly	1		91043706	10.72
36	Lower side panel cotton sticking assembly	1		91043704	7.93
37	Filter cover	1		91043710	1.14