

Exploded View - MGTC1823EA-20

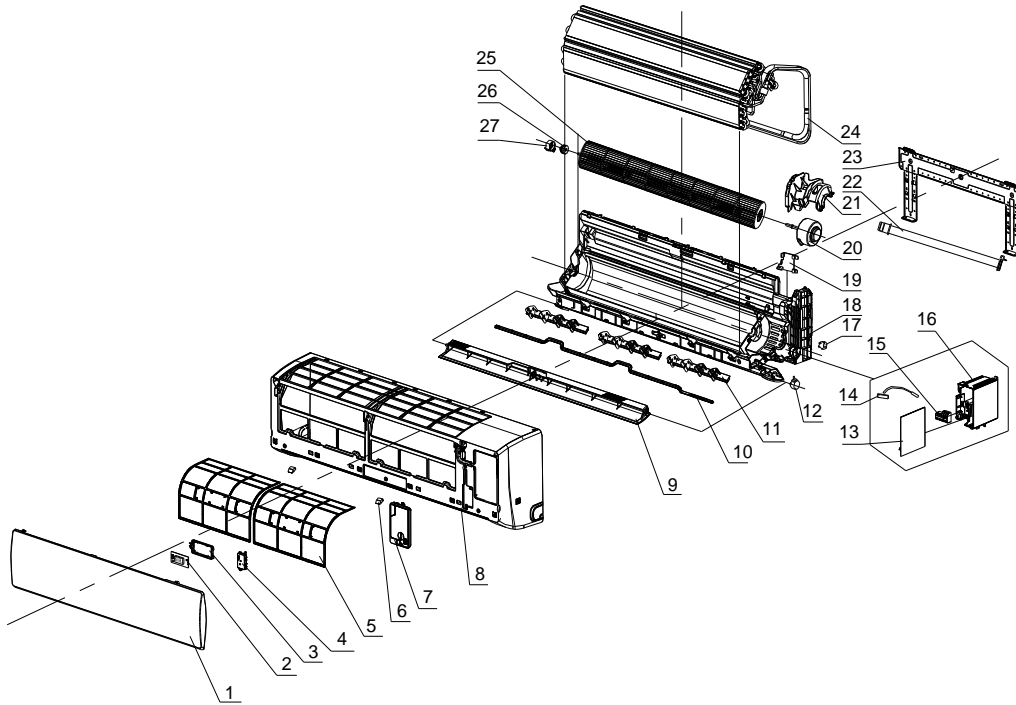

No.	Part No.	Part Name	Qty	Remark
1	41106-002088	Front Panel	1	
2	31102-000085	Display PCB	1	
3	42003-000001	Display PCB Box	1	
4	32001-000140	WIFI PCB	1	
5	42008-000001	Air Filter	1	
6	41108-000066	Screw Cover	2	
7	41211-000079	Electrical Box Cover	1	
8	41106-002351	Face Frame	1	
9	41103-000484	Vane	1	
10	41507-000076	Vertical Vane Connector	1	
11	41101-000042	Vertical Vane Assembly	3	
12	22001-000321	Vane Motor	1	
13	31101-002072	Main PCB	1	
14	10104-100014	Indoor Sensor Assembly	1	
15	11304-100063	Terminal	1	
16	41105-000427	Electrical Box	1	
17	22001-000318	Step Motor	1	
18	41102-000069	Base	1	
19	41101-000224	In And Out Pipe Fixer	1	
20	22001-000240	Indoor Motor	1	
21	42003-000045	Indoor Motor Cover	1	



Exploded View - MGTC1823EA-20

No.	Part No.	Part Name	Qty	Remark
22	42009-000011	Drainage Hose	1	
23	41109-000019	Installation Plate	1	
24	92011-003113	Evaporator	1	
25	42004-000002	Cross Fan	1	
26	42007-000009	Bearing Mount	1	
27	41101-000251	Bearing Mount Holder	1	
28	22013-004233	Remote Controller	1	
29	A1101-002076	Indoor Carton	1	Not shown in Explosion view
30	A2006-000060	Left Foaming	1	
31	A2006-000059	Right Foaming	1	