

Exploded View MGS1833CU

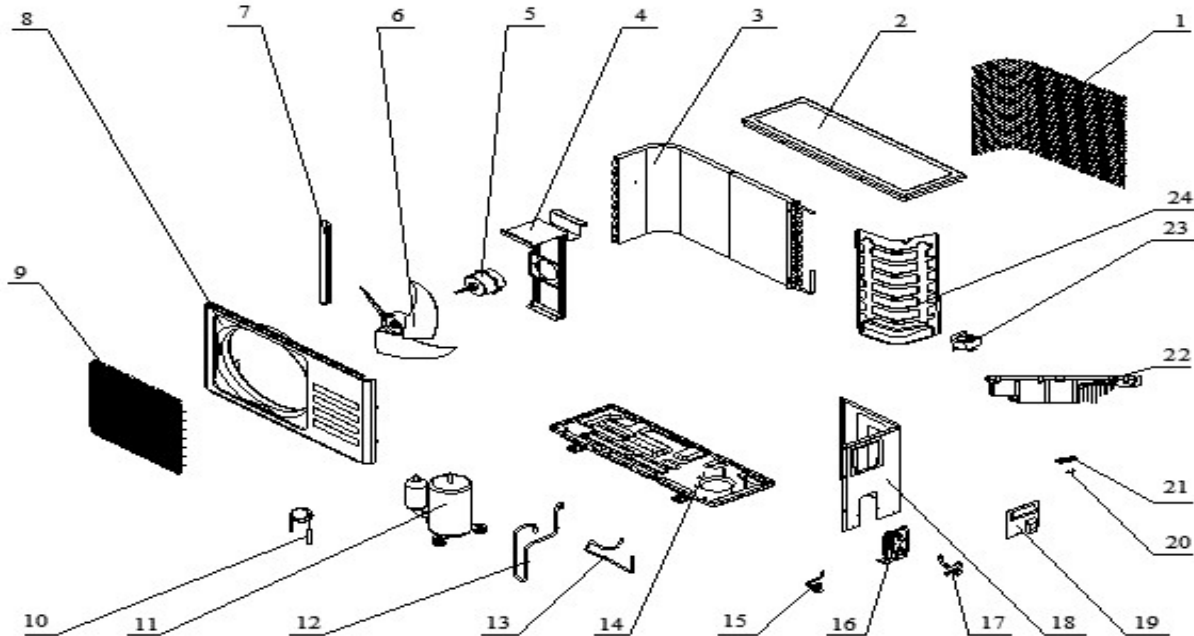

No.	Part No.	Part Name	Qty	Remark
1	42011-000110	Grille	1	Optional
2	41207-000015	Top Cover	1	
3	92011-000487	Condenser	1	
4	41203-000037	Outdoor Motor Supporter	1	
5	22001-000049	Outdoor Motor	1	
6	42004-000073	Propeller Fan	1	
7	41205-000124	Left Grille Supporter	1	
8	41206-000037	Front Plate	1	
9	42011-000070	Fan Guard	1	
10	92007-001812	Capillary Assembly	1	
11	92014-000318	Compressor	1	
12	92006-000318	Discharge Pipe	1	
13	92006-001467	Suction Pipe	1	
14	41202-000166	Base	1	
15	92008-000018	Two-way Valve	1	
16	41204-000010	Valve Supporter	1	
17	92008-000124	Three-way Valve	1	
18	41205-000054	Right Plate	1	
19	41201-000005	Electrical Box Cover	1	
20	42001-000038	Cable Clamp	1	
21	11304-100017	Terminal	1	
22	31201-000915	Outdoor PCB assembly	1	
23	22011-000004	Inductor	1	



Exploded View MGS1833CU

No.	Part No.	Part Name	Qty	Remark
24	41208-000146	Partition plate	1	
25	10104-100033	Pipe Temp. sensor and outdoor Temp. sensor	1	Not shown in explosion view
26	10104-100036	Discharge Temp. sensor	1	
27	A1201-004575	Cabinet Carton	1	
28	A2005-000519	Base carton	1	
29	A1202-000007	Base foaming	1	
30	41213-000002	Cover foaming	1	